

Range  
—  
**ZET**



---

**PRICELIST**  
RETAIL – NOK

---

**NORWAY**  
01.06.2024



## Range

# ZET

ZET is a light and elegant range, designed in collaboration with norwegian RIIS Interiør from Oslo. The furniture is as standard made of ash wood, with a tight and cubic steel frame.

### Designed by

Else Marie Risøe Evensen  
(*Riis Interiør*)



### This range include

Dining tables | Coffee tables  
Sideboards | HIFI sideboards  
Cabinets | Benches  
Shelf furniture | Desks  
Console tables | Nightstands  
Sidetables

## Features



### Design elements

Choose between different designs on plates and legs.



### Custommade

In addition to our many standard sizes we can accommodate special requests.



### Wood colours

Choose between more than 10+ different wood colours in both ash and oak.



### Sustainable choice

Solid wood furniture can last a lifetime with proper maintenance

## Social media

Follow and share with us on Instagram.

 @kristensenfurniture | #kristensenfurniture

## Pricelist- and imagebank

On our Collection-site you as a retailer always have access to the latest pricelists and hundreds of high resolution images and videos  
- *Free to use in your marketing!*

If you do not have a password yet, please contact the Kristensen sales office in Denmark.

### LINK:

[collection.kristensen.com](https://collection.kristensen.com)

# PRICELIST

Round dining table w/ or w/o middle extension and angled legs

—



## Additional information

—

**Special orders larger than standard may be too unstable.**

- Max diameter is 160 cm, sizes above become too unstable.

**Plate thickness: 3 cm.**

**Steel profile: 3x3 cm.**

Item no. 641V

Round dining table w/angled legs (plate thickness 3 cm)				
Size (cm)	Price (NOK)			
	Without middle extension		With middle extension	
	Ash	Oak	Ash	Oak
D160 H74 cm	<b>37.841</b>	<b>47.301</b>	<b>43.556</b>	<b>55.806</b>
D150 H74 cm	<b>32.772</b>	<b>40.965</b>	<b>37.873</b>	<b>48.525</b>
D140 H74 cm	<b>26.041</b>	<b>32.552</b>	<b>30.616</b>	<b>39.227</b>
D130 H74 cm	<b>23.314</b>	<b>29.142</b>	<b>26.657</b>	<b>34.154</b>
D120 H74 cm	<b>20.411</b>	<b>25.513</b>	<b>23.140</b>	<b>29.648</b>
D110 H74 cm	<b>18.475</b>	<b>23.094</b>	<b>21.027</b>	<b>26.940</b>
D100 H74 cm	<b>16.716</b>	<b>20.895</b>	<b>19.091</b>	<b>24.460</b>

1-4 leaves  
2 support legs are provided for tables in the size of 150-160 cm.

1 leaf

\* Comes with 2 support legs

Leaf for tables with middle extension		
Size (cm)	Price (NOK)	
	Item no. 631	
	Plate in quality as the table	
	Ash	Oak
45x160 H3 cm	<b>5.909</b>	<b>7.386</b>
45x150 H3 cm	<b>5.618</b>	<b>7.023</b>
45x140 H3 cm	<b>5.234</b>	<b>6.542</b>
45x130 H3 cm	<b>4.992</b>	<b>6.240</b>
45x120 H3 cm	<b>4.890</b>	<b>6.112</b>
45x110 H3 cm	<b>4.799</b>	<b>5.998</b>
45x100 H3 cm	<b>4.697</b>	<b>5.871</b>

Stainless steel = + 10%

All prices are retail prices in NOK.  
We accept no liability for any errors or omissions.

# PRICELIST

Round dining table w/ or w/o middle extension and straight legs



## Additional information

Special orders larger than standard may be too unstable.

- Max diameter is 160 cm, sizes above become too unstable.

Plate thickness: 3 cm.

Steel profile: 3x3 cm.

Item no. 641

Round dining table w/straight legs (plate thickness 3 cm)				
Size (cm)	Price (NOK)			
	Without middle extension		With middle extension	
	Ash	Oak	Ash	Oak
D160 H74 cm	<b>31.222</b>	<b>39.028</b>	<b>36.808</b>	<b>47.160</b>
D150 H74 cm	<b>26.992</b>	<b>33.740</b>	<b>31.997</b>	<b>40.996</b>
D140 H74 cm	<b>26.692</b>	<b>33.365</b>	<b>31.381</b>	<b>40.207</b>
D130 H74 cm	<b>23.897</b>	<b>29.871</b>	<b>27.323</b>	<b>35.008</b>
D120 H74 cm	<b>20.921</b>	<b>26.151</b>	<b>23.718</b>	<b>30.389</b>
D110 H74 cm	<b>18.937</b>	<b>23.671</b>	<b>21.552</b>	<b>27.614</b>
D100 H74 cm	<b>17.134</b>	<b>21.417</b>	<b>19.568</b>	<b>25.072</b>

1-4 leaves  
2 support legs are provided for tables in the size of 150-160 cm.

1 leaf

\* Comes with 2 support legs

Leaf for tables with middle extension		
Size (cm)	Price (NOK)	
	Item no. 631 Plate in quality as the table	
	Ash	Oak
45x160 H3 cm	<b>5.915</b>	<b>7.393</b>
45x150 H3 cm	<b>5.639</b>	<b>7.049</b>
45x140 H3 cm	<b>5.364</b>	<b>6.705</b>
45x130 H3 cm	<b>5.117</b>	<b>6.396</b>
45x120 H3 cm	<b>5.012</b>	<b>6.265</b>
45x110 H3 cm	<b>4.919</b>	<b>6.148</b>
45x100 H3 cm	<b>4.814</b>	<b>6.018</b>

Stainless steel = + 10%

All prices are retail prices in NOK.  
We accept no liability for any errors or omissions.

# PRICELIST

## Rectangular coffee table



Item no. H45: 6341

Item no. H52: 6342

Coffee table Price (NOK)						
Ash H45 or H52 cm						
L 140	12.151	14.150	16.150	18.380	20.456	22.417
130	11.689	13.612	15.688	17.918	19.841	21.764
120	11.189	13.035	15.342	17.265	18.803	20.764
110	11.036	12.881	14.881	16.650	18.380	20.572
100	10.882	12.651	14.458	16.380	17.995	18.380
90	10.728	12.458	14.227	16.073	16.380	16.650
80	10.651	12.381	14.073	14.227	14.458	14.881
	60	70	80	90	100	110

Coffee table Price (NOK)						
Oak H45 or H52 cm						
L 140	15.568	18.130	20.692	23.549	26.210	28.722
130	14.977	17.440	20.101	22.958	25.421	27.885
120	14.336	16.701	19.657	22.120	24.091	26.604
110	14.139	16.504	19.066	21.332	23.549	26.357
100	13.942	16.209	18.524	20.987	23.056	23.549
90	13.745	15.962	18.228	20.593	20.987	21.332
80	13.647	15.864	18.031	18.228	18.524	19.066
	60	70	80	90	100	110

### Additional information



Plate thickness: 2 cm.

Steel profile: 2x2 cm.

Alternative size = surcharge.

Stainless steel = + 10%

All prices are retail prices in NOK.

We accept no liability for any errors or omissions.

# PRICELIST

## Round coffee table



Item no. H52: 6392

Item no. H45: 6391

		Round coffee table Price (NOK)								
		Ash								
H 52		6.558	7.038	7.518	8.158	8.878	9.358	10.077	10.957	11.357
45		6.398	6.878	7.358	7.998	8.718	9.198	9.917	10.797	11.197
		D 36	42	48	54	60	66	72	78	84

		Round coffee table Price (NOK)								
		Oak								
H 52		8.403	9.018	9.632	10.452	11.375	11.989	12.912	14.039	14.551
45		8.198	8.813	9.428	10.247	11.170	11.784	12.707	13.834	14.346
		D 36	42	48	54	60	66	72	78	84

### Additional information

—

Special orders larger than standard may be too unstable.

Plate thickness: 2 cm.

Steel profile: 2x2 cm.

Alternative size = surcharge.

Round coffee tables are delivered assembled.

Stainless steel = + 10%

All prices are retail prices in NOK.

We accept no liability for any errors or omissions.

# PRICELIST

*Console table w/ or w/o shelf*



Item no. 636

Console table Price (NOK)						
Dimensions (cm)			Ash		Oak	
W	D	H	w/"V"	w/shelf	w/"V"	w/shelf
100	30	80	<b>10.557</b>	<b>11.757</b>	<b>13.526</b>	<b>15.064</b>
110	30	80	<b>10.717</b>	<b>11.997</b>	<b>13.731</b>	<b>15.371</b>
120	30	80	<b>10.957</b>	<b>12.237</b>	<b>14.039</b>	<b>15.678</b>
130	30	80	<b>11.357</b>	<b>12.637</b>	<b>14.551</b>	<b>16.191</b>
150	30	80	<b>12.237</b>	<b>14.156</b>	<b>15.678</b>	<b>18.138</b>
200	30	80	<b>13.436</b>	<b>15.516</b>	<b>17.216</b>	<b>19.880</b>

## Additional information

Console tables are delivered assembled.

Stainless steel = + 10%

All prices are retail prices in NOK.

We accept no liability for any errors or omissions.

# PRICELIST

## Bench

---



Item no. 633

Bench w/"V"				
Dimensions (cm)			Price (NOK)	
W	D	H	Ash	Oak
160	35	45	<b>11.997</b>	<b>15.371</b>
180	35	45	<b>12.157</b>	<b>15.576</b>
200	35	45	<b>12.317</b>	<b>15.781</b>
220	35	45	<b>12.557</b>	<b>16.088</b>
240	35	45	<b>13.037</b>	<b>16.703</b>

### Additional information

---

Plate thickness: 2 cm.

Steel profile: 2x2 cm.

Alternative size = surcharge.

Stainless steel = + 10%

All prices are retail prices in NOK.  
We accept no liability for any errors or omissions.



# PRICELIST

## Shelf furniture

---



Item no. 634

Shelf unit				
Dimensions (cm)			Price (NOK)	
W	D	H	Ash	Oak
140	40	80	<b>17.380</b>	<b>22.268</b>

### Additional information

---

The shelf furniture are delivered assembled.

Stainless steel = + 10%

All prices are retail prices in NOK.  
We accept no liability for any errors or omissions.

# PRICELIST

## Desk w/2 "push" drawers



Item no. H75 635

Item no. H90 637

Desk w/2 drawers				
Dimensions (cm)			Price (NOK)	
W	D	H	Ash	Oak
100	40	75	<b>17.265</b>	<b>22.120</b>
110	40	75	<b>17.841</b>	<b>22.859</b>
120	40	75	<b>18.457</b>	<b>23.648</b>
130	40	75	<b>18.957</b>	<b>24.288</b>
150	40	75	<b>19.995</b>	<b>25.618</b>

## Night stand w/ 1 "push" drawer



Item no. 627

Night stand w/1 drawer				
Dimensions (cm)			Price (NOK)	
W	D	H	Ash	Oak
50	40	60	<b>11.688</b>	<b>14.975</b>

### Additional information

The shelf furniture are delivered assembled.

Stainless steel = + 10%

All prices are retail prices in NOK.

We accept no liability for any errors or omissions.

# PRICELIST

## HIFI sideboard with textile and "push" doors/drawers

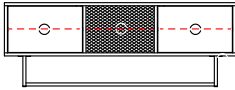
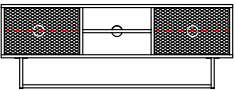
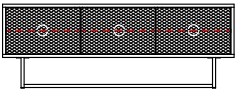
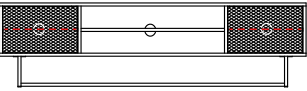
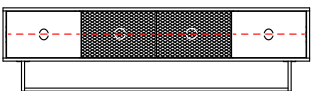

HIFI-sideboard with HIFI-fabric					
Description + drawing	Dimensions (cm)			Price (NOK)	
	W	D	H	Ash	Oak
item no. 6362 2 doors (veneer), 1 door (w/textile), 3 cable holes in the back 	151	40	55	24.171	30.969
item no. 6363 2 doors (w/textile), 1 open space, 3 cable holes in the back 	151	40	55	21.959	28.135
item no. 6364 3 doors (w/textile), 3 cable holes in the back 	151	40	55	22.947	29.401
item no. 6367 2 doors (w/textile), 1 open space, 3 cable holes in the back 	200	40	55	25.604	32.805
item no. 6366 2 doors (veneer), 2 doors (w/textile), 4 cable holes in the back 	200	40	55	26.211	33.582

--- Wood shelf inside



Please note that we can not guarantee that the HIFI fabric works with all infrared devices.

### Overview of which doors are left and right hinged on all ZET cabinets

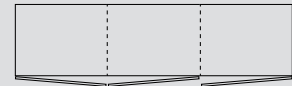

3 sections

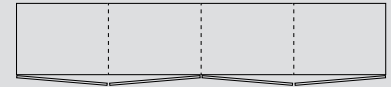

4 sections

### Additional information

Plate thickness: 2 cm.

Steel profile: 2x2 cm.

**Removable wooden shelves**

- max. 20 kg - evenly distributed.

**Adjustable shelves**

The shelves can be adjusted a little bit up/down from the standard position.

Stainless steel = + 10%



All prices are retail prices in NOK.

We accept no liability for any errors or omissions.

# PRICELIST

Wallmounted HIFI sideboard with textile and "push" doors/drawers

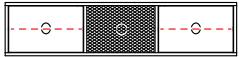

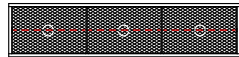
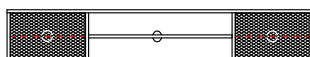
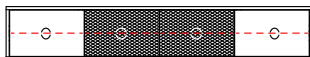
HIFI-sidebaord with fabric - wall mount					
Description + drawing	Dimensions (cm)			Price (NOK)	
	W	D	H	Ash	Oak
item no. 6362W 2 doors (veneer) 1 door (w/textile) 3 cable holes in the back 	151	42	35	24.171	30.969
item no. 6363W 2 doors (w/textile), 1 open space 3 cable holes in the back 	151	42	35	21.959	28.135
item no. 6364W 3 doors (w/textile) 3 cable holes in the back 	151	42	35	22.947	29.401
item no. 6367W 2 doors (w/textile), 1 open space 3 cable holes in the back 	200	42	35	25.604	32.805
item no. 6366W 2 doors (veneer) 2 doors (w/textile) 4 cable holes in the back 	200	42	35	26.211	33.582

--- Wood shelf inside



Please note that we can not guarantee that the HIFI fabric works with all infrared devices.

## Overview of which doors are left and right hinged on all ZET cabinets

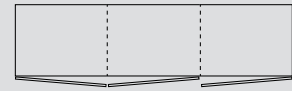

3 sections

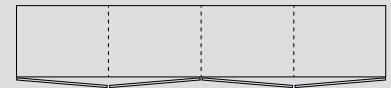

4 sections

## Additional information

Plate thickness: 2 cm.

Steel profile: 2x2 cm.

**Removable wooden shelves**

- max. 20 kg - evenly distributed.

**Adjustable shelves**

The shelves can be adjusted a little bit up/down from the standard position.

Stainless steel = + 10%



All prices are retail prices in NOK.

We accept no liability for any errors or omissions.

# PRICELIST

HIFI sideboard "push" doors/drawer

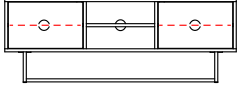

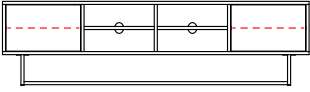
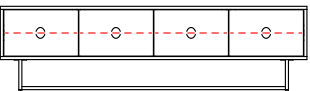
HIFI-sideboard					
Description + drawing	Dimensions (cm)			Price (NOK)	
	W	D	H	Ash	Oak
item no. 6373 2 doors (veneer) 1 open space 3 cable holes in the back 	151	40	55	21.956	28.130
item no. 6374 3 doors (veneer) 3 cable holes in the back 	151	40	55	24.183	30.985
item no. 6375 2 doors (veneer) 2 open spaces 4 cable holes in the back 	200	40	55	25.604	32.805
item no. 6376 4 doors (veneer) 4 cable holes in the back 	200	40	55	26.217	33.591

--- Wood shelf inside

## Overview of which doors are left and right hinged on all ZET cabinets

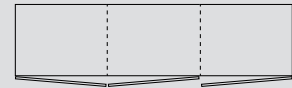

3 sections

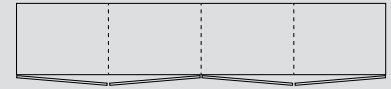

4 sections

## Additional information

**Plate thickness: 2 cm.**

**Steel profile: 2x2 cm.**

**Removable wooden shelves**

- max. 20 kg - evenly distributed.

**Adjustable shelves**

The shelves can be adjusted a little bit up/down from the standard position.

Stainless steel = + 10%





All prices are retail prices in NOK.

We accept no liability for any errors or omissions.

# PRICELIST

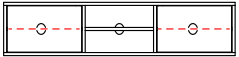
Wallmounted HIFI sideboard "push" doors/drawer



HIFI-sideboard - wall mount						
Description + drawing	Dimensions (cm)			Price (NOK)		
	W	D	H	Ash	Oak	
item no. 6373W 2 doors (veneer) 1 open space 3 cable holes in the back 	151	42	35	<del>22.504</del>	<del>29.555</del>	
item no. 6374W 3 doors (veneer) 3 cable holes in the back 	151	42	35	<del>24.788</del>	<del>32.554</del>	
item no. 6375W 2 doors (veneer) 2 open spaces 4 cable holes in the back 	200	42	35	<del>26.244</del>	<del>34.466</del>	
item no. 6376W 4 doors (veneer) 4 cable holes in the back 	200	42	35	<del>26.873</del>	<del>35.292</del>	

--- Wood shelf inside

## Overview of which doors are left and right hinged on all ZET cabinets

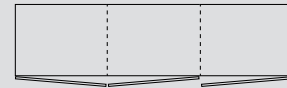

3 sections

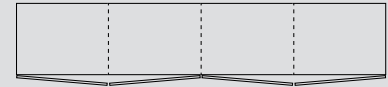

4 sections

## Additional information

**Plate thickness: 2 cm.**

**Steel profile: 2x2 cm.**

**Removable wooden shelves**

- max. 20 kg - evenly distributed.

**Adjustable shelves**

The shelves can be adjusted a little bit up/down from the standard position.

Stainless steel = + 10%





All prices are retail prices in NOK.

We accept no liability for any errors or omissions.

# PRICELIST

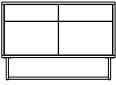
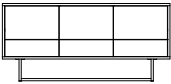
Sideboards w/push drawers + doors. Height 70 cm

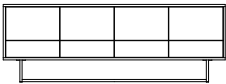

Sideboard H70 cm					
Description + drawing	Dimensions (cm)			Price (NOK)	
	W	D	H	Ash	Oak
item no. 6337 - 2 doors 	102	40	70	<b>21.081</b>	<b>27.686</b>
item no. 6338 - 2 doors, 2 drawers 	102	40	70	<b>25.185</b>	<b>33.075</b>
item no. 6343 - 3 doors, 3 drawers 	151	40	70	<b>32.201</b>	<b>42.289</b>
item no. 6344 - 3 doors 	151	40	70	<b>24.589</b>	<b>32.293</b>
item no. 6345 - 4 doors, 4 drawers 	200	40	70	<b>39.118</b>	<b>51.373</b>
item no. 6346 - 4 doors 	200	40	70	<b>30.480</b>	<b>40.029</b>

--- Wood shelf inside

## Overview of which doors are left and right hinged on all ZET cabinets

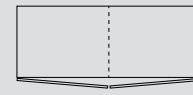

2 sections

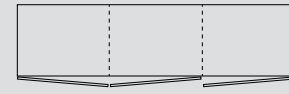

3 sections

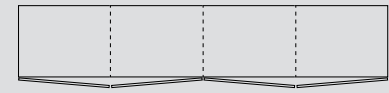

4 sections

## Additional information

**Plate thickness: 2 cm.**

**Steel profile: 2x2 cm.**

**Removable wooden shelves**

- max. 20 kg - evenly distributed.

**Adjustable shelves**

The shelves can be adjusted a little bit up/down from the standard position.

Stainless steel = + 10%

All prices are retail prices in NOK.

We accept no liability for any errors or omissions.

# PRICELIST

Sideboards w/push drawers + doors. Height 85 cm

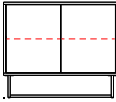
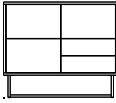
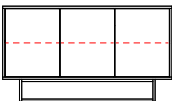
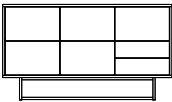
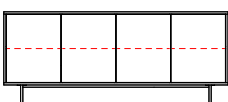
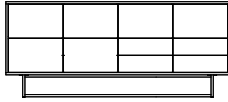

Sideboard H85 cm					
Description + drawing	Dimensions (cm)			Price (NOK)	
	W	D	H	Ash	Oak
item no. 6301 - 2 doors 	102	40	85	<b>24.225</b>	<b>31.815</b>
item no. 6302 - 2 doors, 2 drawers 	102	40	85	<b>30.579</b>	<b>40.159</b>
item no. 6303 - 3 doors 	151	40	85	<b>28.263</b>	<b>37.117</b>
item no. 6304 - 5 doors, 2 drawers 	151	40	85	<b>35.378</b>	<b>46.462</b>
item no. 6305 - 4 doors 	200	40	85	<b>35.080</b>	<b>46.070</b>
item no. 6306 - 6 doors, 4 drawers 	200	40	85	<b>42.957</b>	<b>56.414</b>

--- Wood shelf inside

## Overview of which doors are left and right hinged on all ZET cabinets

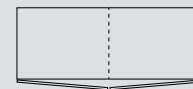

2 sections

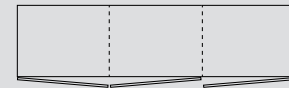

3 sections

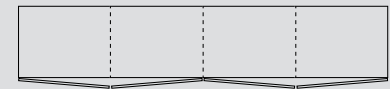

4 sections

## Additional information

**Plate thickness: 2 cm.**

**Steel profile: 2x2 cm.**

**Removable wooden shelves**  
- max. 20 kg - evenly distributed.

### Adjustable shelves

The shelves can be adjusted a little bit up/down from the standard position.

Stainless steel = + 10%

All prices are retail prices in NOK.  
We accept no liability for any errors or omissions.



# PRICELIST

Glass cabinet w/handles on the glass doors.



**BI**  
Handle in black steel



**MI**  
Handle in brass

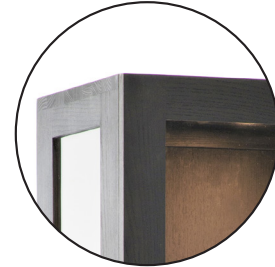

The glass doors are mounted on the outer side of the corpus.  
**Only on item no. 6347 + 6348!**

**Overview of which doors are left and right hinged on all ZET cabinets**

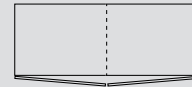

2 sections

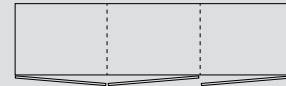

3 sections

### Additional information

**Plate thickness: 2 cm.**

**Steel profile: 2x2 cm.**

**Removable glass shelves.**  
- max. 12 kg - evenly distributed.

**LED light in top of the cabinet.**

**Adjustable shelves.**

The shelves can be adjusted a little bit up/down from the standard position.

**Soft close**

The glass doors with handles are with soft close.

● *Handles - See options on page. 31*

--- *Wood shelf inside*

*We use tempered glass on our vitrines*

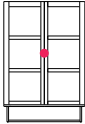
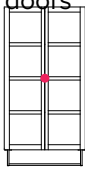
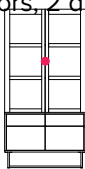
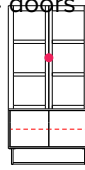
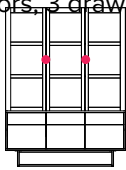
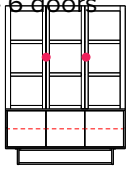
Vitrine					
Description + drawing	Dimensions (cm)			Price (NOK)	
	W	D	H	Ash	Oak
item no. 63570 - 2 doors 	102	40	157	<b>30.609</b>	<b>39.217</b>
item no. 63470- 2 doors 	102	40	200	<b>35.968</b>	<b>46.084</b>
item no. 663480 - 4 doors, 2 drawers 	102	40	200	<b>55.050</b>	<b>70.533</b>
item no. 63530 - 4 doors 	102	40	200	<b>40.489</b>	<b>51.876</b>
item no. 63540 - 6 doors, 3 drawers 	151	40	200	<b>64.930</b>	<b>83.192</b>
item no. 63520 - 6 doors 	151	40	200	<b>59.667</b>	<b>76.449</b>

Stainless steel = + 10%

All prices are retail prices in NOK.

We accept no liability for any errors or omissions.

# WOOD COLOURS



## Images for guiding purpose only!

The wood structure and colour will vary from ash and oak.

We therefore recommend using the wood samples/exhibition furniture to get a more accurate impression.



**ASH C3 / OAK C3**  
Lacquered

We treated this wood with lacque.

**C3 are only made for products without patination.**



**ASH C4 / OAK C4**  
Natural oiled

We treated this wood with our 'Natural oil'.



**ASH C6 / OAK C6**  
White oiled

We treated this wood with our 'White oil'.



**ASH C8 / OAK C8**  
Soaped

We treated this wood with soap.



**ASH C11 / OAK C11**  
Dark grey oiled

We treated this wood with our 'Black oil'.



**ASH C12 / OAK C12**  
Antique brown oiled

We treated this wood with our 'Antique brown oil'.



**ASH C13 / OAK C13**  
Light grey oiled

We treated this wood with our 'Light grey oil'.



**ASH C14 / OAK C14**  
Black stained & oiled

We treated this wood with black stain, and treated it with a wax oil.

**C14 is for legs and storage furniture only!**



**ASH C15 / OAK C15**  
Mocca brown oiled

We treated this wood with our 'Mocca brown oil'.



**ASH C16**  
Warm white oiled

We treated this wood with our 'Warm white oil'.

**C16 is only for ash**



**ASH C20 / OAK C20**  
Grey brown oiled

We treated this wood with our 'Grey brown oil'.



**ASH C44 / OAK C44**  
Black matt lacquered

We treated this wood with black stain, and treated it with matt lacque.

**C44 is only for plates and can only be made for products without patination.**



For more information about maintenance, please visit our website:  
[WWW.KRISTENSEN.COM](http://WWW.KRISTENSEN.COM)



We also offers our own repairoils for our products  
- contact us if you need a pricelist.

**Stainless steel = + 10%**

All prices are retail prices in NOK.  
We accept no liability for any errors or omissions.

## WOOD FINISH



### UP

#### Without patination

The wood is planned and sanded to achieve a smooth surface.

*With few and smaller knots.*

**Storage furniture can only be made with this finish!**



### SC

#### Soft Cracks

Naturally occurring cracks are made more visible which gives a rustic look with cracks in the surface.

*May contain more and larger knots.*

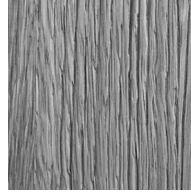

### RL

#### Raw Look

We brush off the layer of softer wood which gives a look of wood that has been roughened by natural wear.

*May contain more and larger knots.*



### FK

#### Filled Knots

The knots are filled and the wood is planned and sanded to achieve a smooth surface.

**Only for OAK!**

## STEEL COLOUR & FINISH

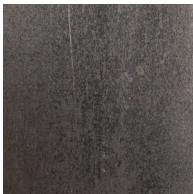

### A

#### Industrial steel

Industrial steel has a raw and matte appearance with shades of colors emerged during casting.

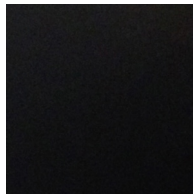

### B

#### Black painted steel

Black painted steel has a graphical and simple look, that fits nicely in most homes.



### C

#### Brushed stainless steel

Brushed, stainless steel has an elegant appearance with a uniform finish created by hand.

**Extra cost!**

## HANDLES



### BI

I-handles in blackpainted steel



### MI

I-handles in brass

**Stainless steel = + 10%**

*All prices are retail prices in NOK.*

*We accept no liability for any errors or omissions.*

# MEASURES

Measures for estimating the number of chairs fitting around these tables

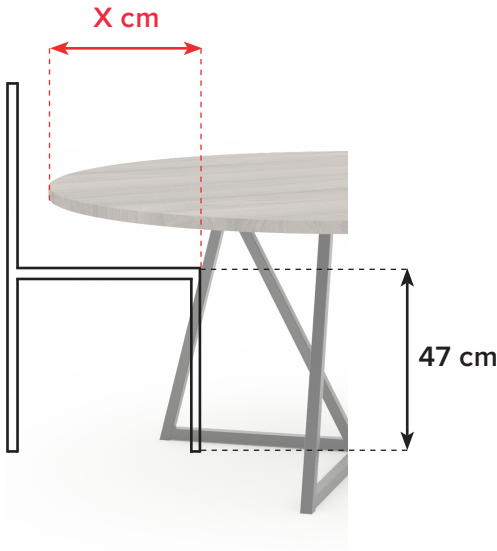

## ITEM NO. 641V

Ø100	X = 26,5 cm
Ø110	X = 31,5 cm
Ø120	X = 31,5 cm
Ø130	X = 31,5 cm
Ø140	X = 31,5 cm
Ø150	X = 31,5 cm
Ø160	X = 31,5 cm

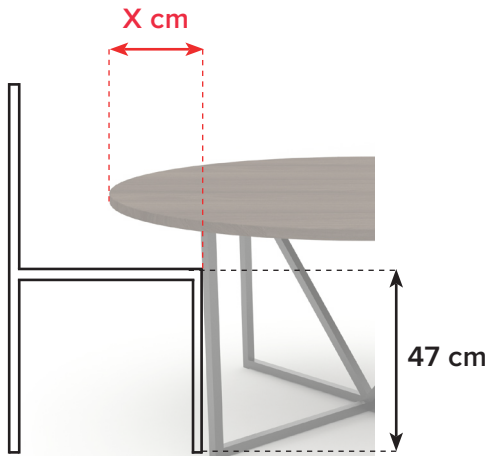

## ITEM NO. 641

Ø100	X = 14 cm
Ø110	X = 14 cm
Ø120	X = 14 cm
Ø130	X = 14 cm
Ø140	X = 14 cm
Ø150	X = 14 cm
Ø160	X = 14 cm

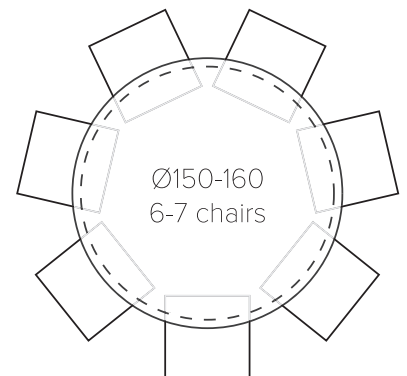
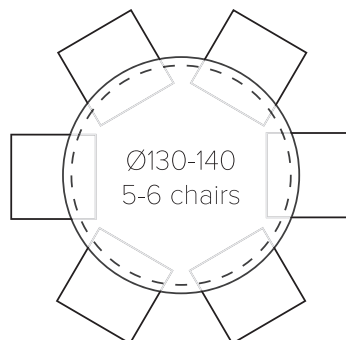
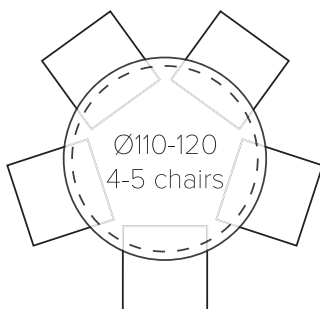

Stainless steel = + 10%

All prices are retail prices in NOK.  
We accept no liability for any errors or omissions.

# KONTAKT

---

## BORDE I SPECIALMÅL

Vi tilbyder gerne alle vore borde i specialmål efter kundens eget ønske. Dette kræver dog en særlig håndtering af produktet igennem hele produktionen, lige fra nye tegninger og maskinindstillinger til indpakning. Vi er derfor nødsaget til at tillægge prisen en procentsats på disse specialbestillinger. Dette uanset om produktet bliver større eller mindre end standard. Hvis du f.eks. ønsker møblet i en mindre størrelse, tillægges prisen 15% på den nærmeste standardstørrelse.

*Kontakt os gerne for mere information!*

### Hovedkontor, Denmark

**ADRESSE:**

Kristensen & Kristensen A/S  
Storstrømsvej 44  
6715 Esbjerg N  
DK - Denmark

**TELEFON:**

+45 75470303

**FAX:**

+45 75470304

**HJEMMESIDE:**

[www.kristensen.com](http://www.kristensen.com)

**ÅBNINGSTIDER:**

Mandag: 10.00–16.00  
Tirsdag: 08.00–16.00  
Onsdag: 08.00–16.00  
Torsdag: 08.00–16.00  
Fredag: 08.00–15.00

**MAIL:**

[kristensen@kristensen.dk](mailto:kristensen@kristensen.dk)

**ORDRE MAIL:**

[order@kristensen.dk](mailto:order@kristensen.dk)

**REKLAMATION:**

[claim@kristensen.dk](mailto:claim@kristensen.dk)

### Norge

**Markedsansvarlig**

-

**Paal Stenvaag**

Besøker butikker i Nord-Norge og Sør-Norge.

—

✉ [post@mobelpaal.no](mailto:post@mobelpaal.no)

☎ +47 926 18 628

– Døgnåpent –

**Representant:**

Oppfølging av butikker på Vestlandet og i Trøndelag

-

**Anders Lie**

—

✉ [lieagentur@gmail.com](mailto:lieagentur@gmail.com)

☎ +47 400 84 333

**Representant:**

Oppfølging av butikker på Østlandet (t.o.m. Lyngdal)

-

**Erik Orderud**

—

✉ [erik.orderud@gmail.com](mailto:erik.orderud@gmail.com)

☎ +47 907 75 318